

Extending UML to Model Navigation and Presentation in Web Applications

Nora Koch^{1,2}, Hubert Baumeister¹, Rolf Hennicker¹ and Luis Mandel²

¹Ludwig-Maximilians-University Munich
Oettingenstr. 67
80538 München, Germany
{kochn,baumeist,hennicke}@informatik-
uni-muenchen.de

²F.A.S.T.
Applied Software Technology GmbH
Arabellastr. 17
81925 München, Germany
{koch,mandel}@fast.de

ABSTRACT

This paper presents a UML Profile for Web applications. It is a UML extension based on the general extension mechanisms provided by the UML that defines specific stereotypes to model the navigational and presentational aspects of Web applications. This profile is part of a methodology for the analysis and design of Web applications. This methodology performs separate steps for conceptual, navigational and presentational modeling in a similar way as it is proposed by other methods for hypermedia or Web design. The novelty of this approach consists in the modeling techniques and notation used, that are entirely based on the Unified Modeling Language.

KEYWORDS: Web Applications, UML Profile, Web Engineering, UML Extension, Navigation, User Interface.

1. INTRODUCTION

Web applications provide users with information and navigation facilities to access information systems and may provide them with functionality to manipulate this information. The development of Web applications requires abilities to choose multimedia contents, to define an adequate structure, to design the user interface and to select the appropriate implementation technique. Ad hoc building processes focus on the contents and the presentation while paying little attention to the navigational structure. Quality of a Web application depends not only on the richness of contents and high-quality graphic design, but also on a well-structured navigation.

The objective of this paper is to show how *UML notation* and *UML modeling techniques* can support the analysis and design phases in the development process of Web applications. UML stereotypes are specified for navigational and presentational model elements according to the mechanisms for standard extensions defined in the UML.

These UML modeling techniques are used in a model-based approach for the systematic building of Web applications proposed by Hennicker and Koch in [6]. It is a methodology that allows for a partially automated generation of templates for Web applications. This process makes a clear distinction between the conceptual design of the domain, the design of Web navigational structure and the visual representation of the information in a similar way as it is proposed by other hypermedia design methods, such as OOHDH [11] and partially by EORM [9], RMM [7] and WSDM [5]. The experience obtained with the use of these methods in work performed at the Ludwig-Maximilians University, e.g. [10,13], demonstrated the need to migrate to the UML notation and to improve the notation used for the presentational modeling.

The methods mentioned above use existent object-oriented models for the conceptual design or are based on entity-relationship principles. But all of them introduce an own notation and diagrammatic techniques for navigational and/or user interface design. The models proposed in [1,6] are built with well-known UML model elements and extensions [3,12]. These extensions are defined following the UML extension mechanisms. A UML compliant method has important advantages: UML is a standard for modeling object-oriented systems, documentation about syntax and semantics of the UML modeling elements is already available; and the most important one, case tools supporting UML can be used in Web engineering.

This paper is structured as follows: Section 2 provides an overview of the main UML modeling techniques that can be used in the analysis and design of Web applications. Section 3 presents a set of stereotypes suggested for the basic modeling concepts used in the navigational and presentational models. In Section 4 a simple example is given. In the last Section some concluding remarks and an overview of future work is outlined.

2. WEB MODELING WITH UML TECHNIQUES

A model-based approach development of Web applications can be performed using UML techniques and UML notation. Web analysis and design usually takes into account a clear separation of contents, navigation and presentation, i.e. it is performed in the following steps: conceptual, navigational and presentational design.

Part of the activities of the conceptual, navigational and presentational design are the constructions of models and their graphical representation. These models consist of UML standard model elements or specific model elements – stereotypes – defined according to the UML extension mechanisms. The *conceptual design* produces a conceptual model of the problem domain defined through classes and associations between classes relevant to the domain. The conceptual model is represented with a UML class diagram.

The basis of the *navigation design* is the conceptual model, and the outcome is a navigational model, which can be seen as a view over the conceptual model. The navigational model is defined in a two step process. In the first step the navigational space model is defined and in the second the navigational structure model is built. The *navigation space model* defines a view on the conceptual model showing *which* classes of the conceptual model can be visited through navigation in the Web application. A UML class diagram is used for the graphical representation of the navigation space model that is built with the stereotyped classes – navigational class – and direct navigability associations. The *navigational structure model* defines the navigation of the application, i.e. how navigational objects are visited. It is based on the navigation space model, but also additional model elements are included in the class diagram to perform the navigation between navigational objects: *menus, indexes, guided tours, queries, external nodes* and *navigational contexts*. All these stereotypes are defined in the next section.

The presentational design supports the modeling of an *abstract user interface* showing how the navigational structure is presented to the user. Presentational design means defining the way how navigational nodes will appear, selecting user interface objects to activate navigation, and determining which interface transformations will take place. To achieve this purpose, a static and a dynamic presentational model is built.

The static presentational model is represented by UML composition diagrams that describe how the user interfaces are built. A user interface object can be either a primitive user interface object like text, image and button, or a composition of user interface objects. For the most frequently used user interface objects we define stereotypes according to the extension mechanism provided by UML. These user interface objects are: *anchor, text, image, audio, video, form, button, collection and anchored collection* (see Section 3). The same navigational structure may yield different presentations depending on the restrictions of the target platform and the technology used, such as different browsers, stylesheets or layers. For each navigational node at least one presentational object has to be defined. If the presentation of an object depends on the navigational context within the navigational object is visited, one presentational object for each context has to be specified.

In [6] two variants are analysed for the presentational modeling: the menu-based and the map-based presentational modeling. The dynamic presentational model is represented by UML sequence diagrams and UML state diagrams describing the collaborations and behaviours of the navigational objects and access primitives, i.e. how navigation is activated and which user interface transformations take place.

3. STEREOTYPES FOR MODELING WEB APPLICATIONS

This UML Profile defines a set of stereotypes that are used in the construction of intuitive analysis and design models in the development of Web applications. These models are the navigation space model, the navigation structure model and the static presentation models.

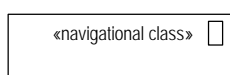

Fig. 1: Navigational Class

Navigational Class. The navigational class represents a conceptual class whose instances are visited by the user during navigation. The icon used for the stereotype «navigational class» is shown in Fig. 1.

Direct Navigability. Associations in the navigation model are interpreted as direct navigability from the source navigation class to the target navigation class. Hence their semantics is different from the associations used in the conceptual model. To determine the directions of the navigation the associations of this model are directed (possibly bidirected). This is shown by an arrow that is attached to one or both ends of the association. As in the navigation class diagrams all associations with the exception of composition are of type direct navigability; often this stereotype is not explicitly written.



Fig. 2: Index

Index. An index is modeled by a composite object which contains an arbitrary number of index items. Each index item is in turn an object which has a name and owns a link to an instance of a navigational class. Any index is a member of some index class which is stereotyped by «index» with a corresponding icon as shown in Fig. 2. An index class must be built conform to the composition structure described in [6]. Hence the stereotype «index» is a restrictive stereotype in the sense of [2].



Fig. 3: Guided Tour

Guided Tour. A guided tour is an object which provides sequential access to the instances of a navigational class. The corresponding icon for the stereotype «guidedTour» is depicted in Fig. 3. Any guided tour class must be connected to a navigational class by a directed association which has the property {ordered} (see Fig. 6).



Fig. 4: Query

Query. A query is represented by an object which has a query string as an attribute. (This string may be given, for instance, by an OCL select operation.) The icon for the stereotype «query» is depicted in Fig. 4. As shown in Fig. 6, any query class is the source of two directed associations related by the constraint {xor}. In this way it is modeled that a query with several result objects must first lead to an index which then allows to select a particular instance of a navigational class.



Fig. 5: Menu

Menu. A menu is a composite object which contains a fixed number of menu items. Each menu item has a constant name and owns a link either to an instance of a navigational class or to an index, guided tour or query. Any menu is an instance of some menu class which is stereotyped by «menu» with a corresponding icon as shown in Fig. 5. A menu class must be built conform to the composition structure of classes described in [6]. Hence the stereotype «menu» is a restrictive stereotype according to the classification of stereotypes given in [2].

Note that the navigation structure of Web applications composed of navigational classes and access primitives, such as indexes, guided tours, queries and menus are built according to the analysis pattern shown in Fig 6.

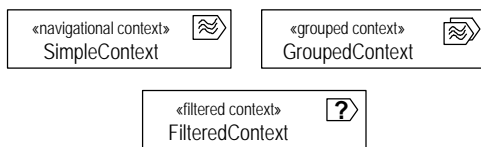

Fig. 7: Simple Context, Grouped Context, Filtered Context

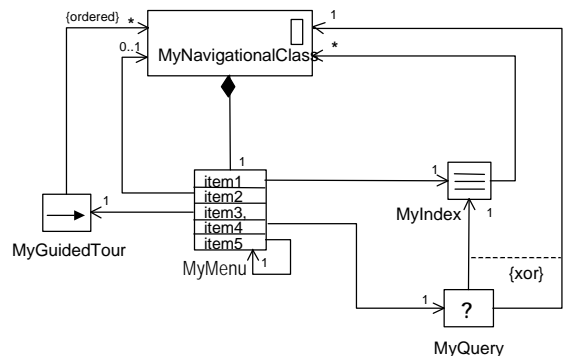

Fig. 6: Navigational Structure Pattern

Context. A context models a composite of a sequence of navigational objects for which an order is provided [11]. It includes a menu with menu items previous, next and/or back allowing for access to the previous/next object as well as to go back to the index or guided tour. Fig. 7 depicts the three types of contexts defined in [1].

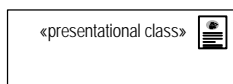

Fig. 8: Presentational Class

Presentational class. A presentational class models the presentation of a navigational class or an access primitive, such as an index, a guided tour, query or menu. Instances of a presentational class are containers which comprise modeling elements like texts, images, video sequences, audio sequences, anchors, collections (i.e. lists of texts, images, etc.), anchored collections (i.e. lists of anchors), etc. Fig. 8 shows the corresponding icon.

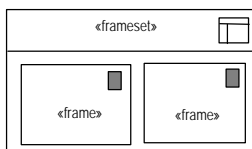

Fig. 9: Frameset and Frame

Frameset and Frame. A frameset is a top level element which is modeled by a composite that contains (lower level) presentational objects but may also contain an arbitrary number of nested framesets. An area of the frameset is assigned to each lower level element – so called frame. The icons chosen for the stereotype «frameset» and «frame» are depicted in Fig. 9. (The same stereotype and a similar icon is also used in [4]). A frameset must be built conform to the composition structure defined in [6].

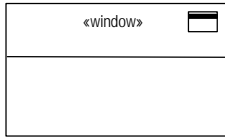

Fig. 10: Window

Window. A window is the area of the user interface where framesets or presentational objects are displayed. A window can be moved, resized and reduced to an icon. It includes at least two buttons, one to transform the window into an icon and one to close the window. Fig. 10 depicts the stereotyped class for a window.

Fig. 11 shows the icons chosen for the stereotypes of the modeling elements presented below. They are used in the presentational design of Web applications in addition to presentational objects, window, framesets and frames. They describe the content of the presentational templates that are usually built based on the attributes of the presentational classes and must follow the composite rules of the pattern presented in Fig. 11.

Text. A text is a sequence of characters.

Anchor. An anchor is a clickable text which is the starting point of a navigation establishing the relationship to other nodes.

Button. A button is a clickable area which has an action associated to it. Examples of actions are `playVideo`, `displayImage`, `stopAudio` and `runApplet`. Note that buttons can also be trigger of navigation.

Image, audio and video. Image, audio and video are multimedia objects. An image can be displayed; audio and video can be started, stopped, rewinded and forwarded.

Form. A form is used to request information from the user who supplies information in one or more input fields or selects options from a browser or checkbox.

Collection. A collection is a list of text elements that is introduced as a stereotype to provide a convenient representation of composites. Note that details, such as whether the collection will be laid out horizontally or vertically are not specified.

Anchored collection. An anchored collection is a list of anchors that is introduced as stereotype to provide a convenient representation of a collection of anchors.

4. EXAMPLE APPLICATION

As an example to illustrate the UML techniques and UML profile presented in this paper, some models of the Web site of an online library are presented. This online library offers information about publications to registered and anonymous users. The publication information comprises journals, books and proceedings. They are described by a title, a number, a publisher, a publishing date, a set of articles and authors for each article. Books consist of exactly one article whose title is the same as the book title. In addition, for each article a set of keywords is stored. Fig 12 shows a navigational structure model for the online library application and Fig. 13 shows two variants for the presentation of the publication frameset: a menu-based presentation and a map-based presentation.

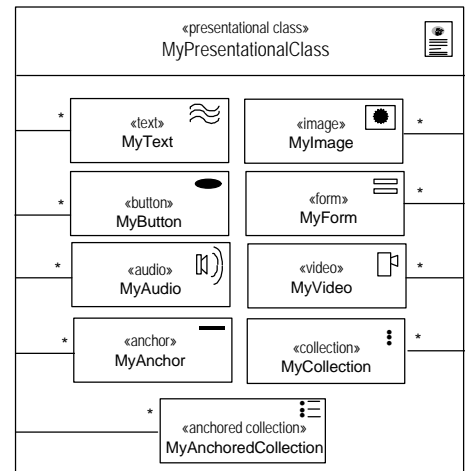

Fig. 11: Presentational Stereotypes

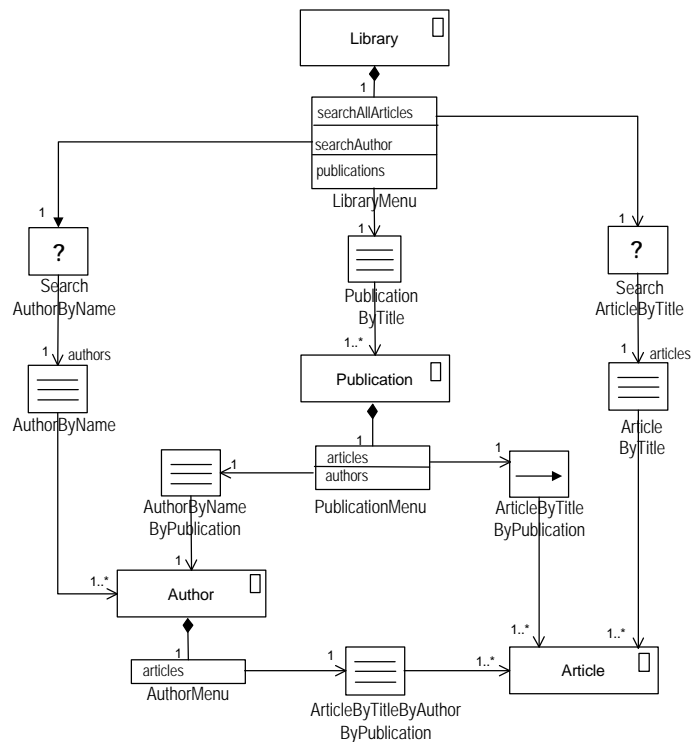

Fig. 12: Navigational Structure Model for the Online Library Application

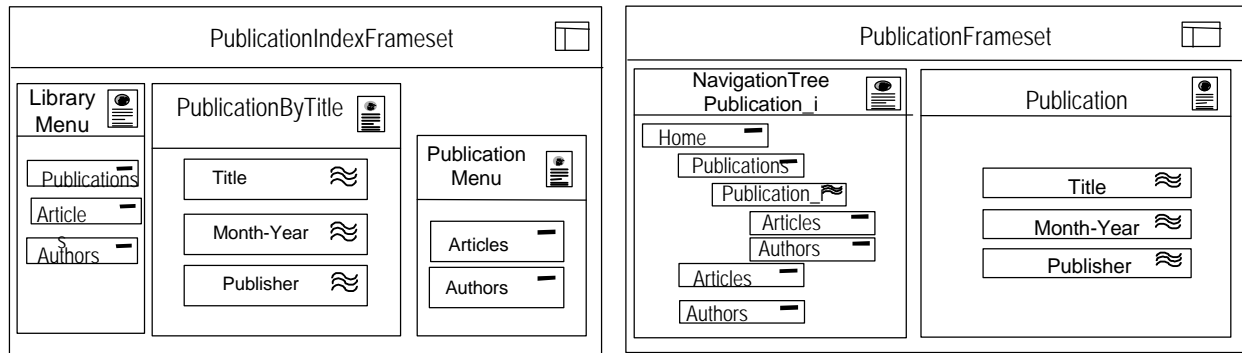

Fig. 13: Publication Frameset for the menu-based and Map-based Variants of the Presentational Model

5. CONCLUDING REMARKS

In this paper a UML profile is presented to model the navigation and the presentation according to the UML standard extension mechanisms. The mechanism used is the definition of stereotypes. To restrict the UML as modeling language has the advantage of using a well-known standard, and therefore the development may be supported by existing case tools.

The defined stereotypes are used in appropriate models supporting analysis and design of Web applications. They are part of the UML-based methodology described in [6] which allows for a systematic construction of Web applications, i.e. of a conceptual model, a navigational model based on the conceptual model and a presentational model that uses as basis the navigational model. The models that profit from the UML extension are the navigational space model, the navigational structure model and the static presentational model. The analysis and design steps briefly mentioned in this paper are part of the whole Web engineering process presented in [8]. It is an engineering process based on the Unified Development Process that describes the requirements capture, analysis, design, implementation, maintenance as well as the project management and quality control workflows.

The models briefly outlined in this paper and the UML profile are currently used in the development of the Knowledge Management System at FAST. Future work will focus on the use of OCL constraints [14] as an extension mechanisms when a more detailed or formal specification is required and on the refinement of the dynamic modeling aspects of the methodology.

ACKNOWLEDGEMENT

We would like to thank Martin Wirsing for his helpful suggestions and comments.

REFERENCES

1. Baumeister, H., Koch, N. and Mandel L. *Towards a UML Extension for Hypermedia Design*. In Proceedings UML'99 Conference, France, R., Rumpe, B. (Eds), LNCS, Vol. 1723, Springer Verlag, 614-629, 1999.
2. Berner S., Glinz M., Joos S. *A classification of stereotypes for object-oriented modeling languages*. In Proceedings «UML»'99, France, R., Rumpe, B. (Eds), LNCS, Vol. 1723. Springer-Verlag, 249-264, 1999.
3. Booch G., Rumbaugh, J. and Jacobson, I. *Unified Modeling Language User Guide*. Addison Wesley, 1999.
4. Conallen J. *Building Web Applications with UML*. Addison Wesley, 1999.
5. De Troyer, O. and Leune, C. WSDM: a User-Centered Design Method for Web Sites. Proceedings of the 7th International World Wide Web Conference, 1997.
6. Hennicker R. and Koch N. *A UML-based Methodology for Hypermedia Design*. UML'2000, to appear, 2000.
7. Isakowitz, T., Stohr, E. and Balasubramanian, P. *A Methodology for the Design of Structured Hypermedia Applications*. Communications of the ACM, 38(8),34-44, 1995.
8. Koch N. *Hypermedia Systems Development based on the Unified Process*. Technical Report 0003, Ludwig-Maximilians-University Munich, 2000.
9. Lange, D. *An Object-Oriented Design Approach for Developing Hypermedia Information Systems*. Journal of Organizational Computing and Electronic Commerce, Vol. 6(3), 269-293, 1996.
10. Peschke S., *Entwicklung eines Intranets zur wissensbasierten Unternehmenskommunikation*, Diploma Thesis, 1999.
11. Rossi, G. *Object-oriented Hypermedia Design*, Thesis, 1996. (in Portuguese).
12. UML Document Set, Version 1.1 September 1997, Rational. <http://www.rational.com/uml/references>
13. van der Leeden C., *Analyse, Design und Implementierung einer Intranet Anwendung zur Unterstützung der Vertriebsprozesse* Diploma Thesis, 1998.
14. Warmer, J. and Kleppe, A. *The Object Constraint Language*. Addison Wesley. 1999.